

*Habillage PVC
pour rives de toitures et avant-toits*

deceuninck



Sous-toiture

DECOROC
by deceuninck

www.deceuninck.fr

Revêtements PVC pour rives de toitures et avant-toits

Deceuninck® vous propose une gamme très diversifiée de produits. Tant pour la construction neuve que pour la rénovation, les profilés Deceuninck® vous garantissent un résultat impeccable, même aux endroits les plus difficiles.

Vous cherchez une harmonie parfaite entre vos menuiseries, votre bardage et votre sous-toiture, selon votre architecture? Vous préférez donner libre cours à votre créativité en jouant avec les différents styles et couleurs?

Chez Deceuninck les deux sont possibles.

Principaux domaines d'application

HABILLAGE DE RIVES



SOUS-TOITURE



AVANTAGES :

- pose aisée
- facile à travailler
- gamme étendue
- large éventail de coloris
- facile à entretenir
- longue durée de vie
- uniformité des couleurs avec les profilés de châssis **zendow**®
- pour le neuf et la rénovation
- résistant aux chocs
- imputrescible

**100%
recyclable**

Garantie 10 ans*

* selon couleurs et références

Une solution complète pour l'habillage des dessous de toit

1. Bandeaux de rive alvéolaires & cellulaires



2. Habillages de sous-faces alvéolaires



3. Accessoires de finition coordonnés



Accessoires spécifiques
pour planches arrondies



Accessoires spécifiques
pour planches équerre



De la couleur
jusqu'au moindre détail

Voir en pages 6 et 7 l'ensemble des accessoires disponibles

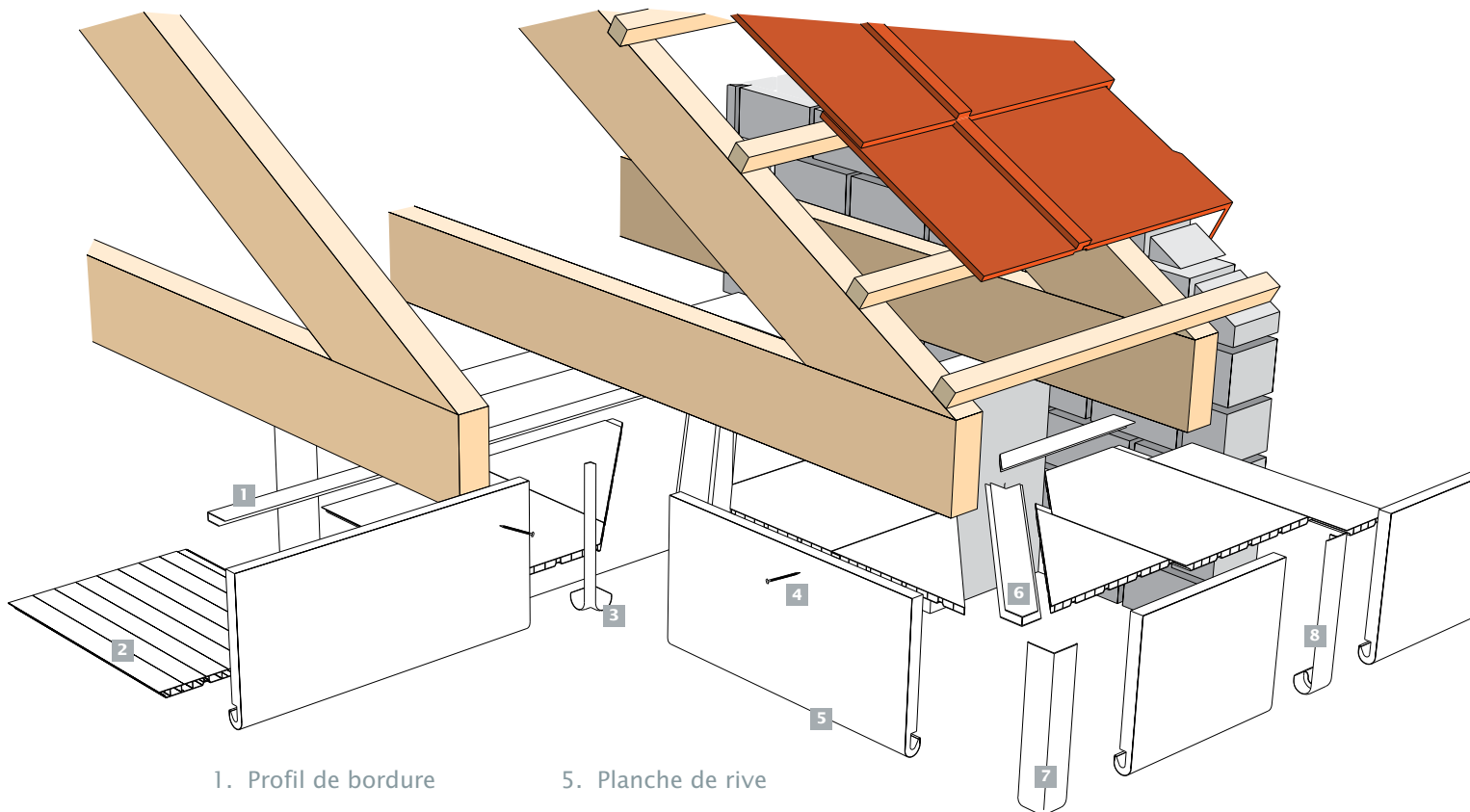

- | | |
|----------------------------|-----------------------|
| 1. Profil de bordure | 5. Planche de rive |
| 2. Planchette de sous face | 6. Profil de jonction |
| 3. Angle intérieur | 7. Angle extérieur |
| 4. Pointe | 8. Jonction |

Exemple de montage avec planche et finition arrondies

Une mise en œuvre simple

CONSEILS & ASTUCES DU PRO



1. Fixer un tasseau sur la maçonnerie puis, le profilé de bordure 109 contre la maçonnerie.



2. Fixer le bandeau aux extrémités des chevrons. Vérifier le niveau et l'alignement.



3. Couper les profilés de remplissage en laissant un jeu, indispensable pour la mise en place.



4. Ce jeu assure également la dilatation des profilés.



5. La fixation par pointe, clip, ou vis sera assurée côté languette.



6. En règle générale la pose des planchettes est perpendiculaire à la façade.



7. Les retours sont faciles à réaliser à l'aide d'un profilé de jonction.





Un grand souci du
détail

CONSEILS & ASTUCES DE PRO :



La grille 149 est équipée d'une moustiquaire qui empêche le passage d'insectes tout en permettant une ventilation optimale de la sous-face (installation facile à clipser).



Le design de la face intérieure du bandeau de rive P1150 permet une ventilation optimale du bandeau bois existant et le protège ainsi de l'humidité.



Lorsque la longueur des planchettes de sous face excède 50 cm et/ou lorsqu'elles sont en couleurs, nous conseillons l'utilisation de clips de fixation en inox P111.



Une large collection de couleurs



3 finitions :

14 Teintes plaxées :
bois naturel et bois peint

020 Chêne naturel		004 Gris RAL 7001*
110 Chêne or		076 Rouge vin RAL 3005*
145 Chêne irlandais		068 Gris quartz RAL 7039*
146 Merisier		072 Gris anthracite RAL 7016*
143 Cèdre gris		025 Chêne foncé
154 Noyer		008 Brun chocolat RAL 8022*
111 Bois de rose		665 Gris agathe RAL 7038*

4 Teintes masse





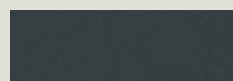













003 Blanc RAL 9016*		007 Gris RAL 7047*
015 Beige RAL 1013*		012 noir RAL 9005*

1 Teinte thermolaquée Décoroc®







072
Gris anthracite
RAL 7016*

TEINTES

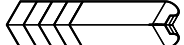

Réf.	Dessin	Hauteur du profil en mm	PLAXÉES				MASSE			
			 Gris anthracite 1072 RAL 7016	 Chêne doré 1110	 Chêne Irlandais 1145	 Merisier 1146	 Blanc 003 RAL 9016	 Gris clair 007 RAL 7047	 Beige 015 RAL 1013	 Noir 012 RAL 9005
P80		150								
P81		175								
P82		225								
P1149		175								
P1150		200								
P1152		250								
P1251		175								
P1252		200								
P1253		225								
P1264		250								

Planches arrondies



Accessoires

P1066		250							
P1067		250							
P1068		150							
P212		100							
P1163		300							
P86		450							
P83	Platine pour profilés 81 / 82								
P84	Etrier pour profilés 81 / 82								
P87	Platine pignon pour 81 / 82								





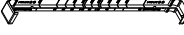

Planches équerres moulurées

P1401		175							
P1403		225							

Accessoires

P1406		500							
P1407		500							
P1408		500							









Fixations

P1090		30								
P1091		40								
P1092		50								
P1093		65								
P1094		30	18 couleurs							
P1096*		30								









Codes RAL approchants

*Pointe inox

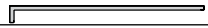

TEINTES

Réf.	Dessin	Hauteur du profil en mm	PLAXÉES			THERMOLAQUÉE	MASSE			
			 Chêne doré 1110	 Chêne Irlandais 1145	 Merisier 1146	 Gris anthracite 6072 RAL 7016	 Blanc 003 RAL 9016	 Gris clair 007 RAL 7047	 Beige 015 RAL 1013	 Noir 012 RAL 9005



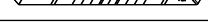
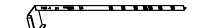

Planches équerres

P1026		200							
P1027		275							
P1030		400							
P1031		300							
P1032		230							
P1034		175							
P1035		150							
P1198		200							
P1199		175							



Accessoires

P1155		500							
P1156		500							
P1157		300							
P1158		300							
P1159		300							

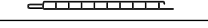
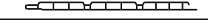
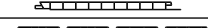
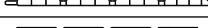
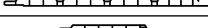
Habillage de sous face

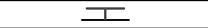
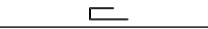

P118		125							
P123		80							
P149*		Diam. 68							
P130		165							
P135		200							
P144		165							
P145		250							
P153		250							
P186		100							

Accessoires



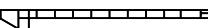

P103		66 X 13							
P108		40 X 13							
P109		25 X 13							
P111**									

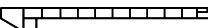
*existe également en brun foncé (008) et caramel (61) – **clips inox



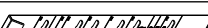





Planches de rives équerres alvéolaires

Réf.	Dessin	Hauteur du profil en mm	TEINTE
			MASSE
			 Blanc 003 RAL 9016
P131		210	
P156		160	
P133		135	

Accessoires

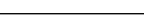
P157		480	
P166		135	
P177		435	
P178		435	

Planches planes et jonction

Réf.	Dessin	Hauteur du profil en mm	TEINTES		
			PLAXÉES	THERMOLAQUÉE	MASSE
			 Blanc 003 RAL 9016	 Gris anthracite 6072 RAL 7016	 Blanc 003 RAL 9016
P1040		150			
P1041		215			
P1042		300			
P1043		100			
P1160		437			

Codes RAL approchants

Votre partenaire Deceuninck

Les partenaires certifiés Deceuninck appartiennent à un réseau de revendeurs mettant un point d'honneur à fournir un service et un travail soignés. Ce réseau est pour vous la garantie d'une installation correcte et d'un service après-vente de qualité, et par conséquent d'une valeur ajoutée pour votre produit Deceuninck.



Fenêtres, Portes et Volets

Nos profilés offrent un parfait équilibre entre rendement énergétique et confort de vie. Les solutions que nous proposons en matière de fenêtres, portes et volets améliorent sensiblement votre qualité de vie. Elles présentent d'excellentes propriétés thermique et phonique, renforcent votre sécurité et existent dans différents coloris.

Aménagement extérieur

Les terrasses et panneaux d'occultation en composite, portails et clôtures en PVC ont été conçus pour durer. En s'intégrant naturellement et harmonieusement à votre propriété, nos systèmes d'aménagement extérieur lui apportent une réelle valeur ajoutée.

Bardage et Sous-toiture

Nos systèmes de bardage et sous-toiture sont constitués de PVC et de notre matériau Twinson unique certifié PEFC. L'extérieur de votre habitation conservera sa beauté pendant de nombreuses années, sans avoir à repeindre les profilés PVC ou le bardage Twinson. Faciles à poser, ces systèmes combinent élégance et entretien minimal.

Décoration intérieure

Deceuninck propose un large choix de teintes et finitions pour lambris, tablettes de fenêtres et plinthes. Il n'a jamais été aussi simple de changer sa décoration.



L'engagement de Deceuninck en matière d'innovation, d'écologie et de design nous impose un objectif précis : construire une habitation durable. Une habitation présentant un meilleur rendement énergétique et un aspect plus séduisant. Deceuninck utilise dans le monde entier des matériaux de pointe et fabrique des produits à fortes longévité et isolation, qui demandent peu d'entretien et qui peuvent être recyclés à 100 %. En outre, nos valeurs nous permettent de bâtir un monde meilleur pour nos partenaires et utilisateurs finaux.



Building a sustainable home

Deceuninck SAS

Zone Industrielle • Impasse des bleuets • 80700 Roye
T +33 3 22 87 66 66 • F +33 3 22 87 66 67
deceuninck.sa@deceuninck.com

