

BOISSEAUX POUZZOLANE

T 300 N2 D3 0(100)

Conforme à la norme NF EN 1858

Autres caractéristiques : voir documentation fournie sur demande

BOISSEAUX POUZZOLANE PLEINS :

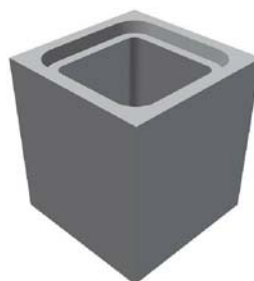
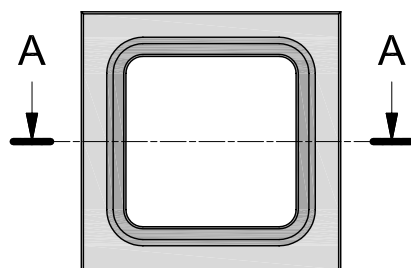

A-A

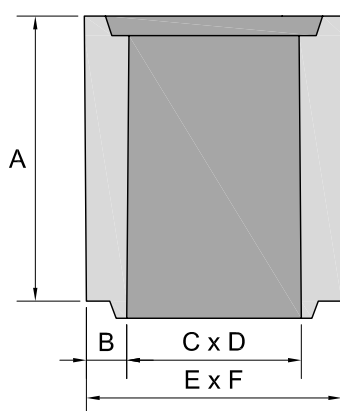

Code Article	Désignation	A (mm)	B (mm)	C (mm)	D (mm)	E (mm)	F (mm)	Poids (Kg)	NF
380005	200 x 200	330	50	200	200	300	300	32	NF
380010	200 x 400	250	50	200	400	300	500	34	NF
380025	250 x 250	250	50	250	250	350	350	31,5	NF
380030	300 x 300	250	50	300	300	400	400	36,5	NF
012050	300 x 500	250	50	300	500	400	600	42	NF

BOISSEAUX POUZZOLANE ALVEOLES :

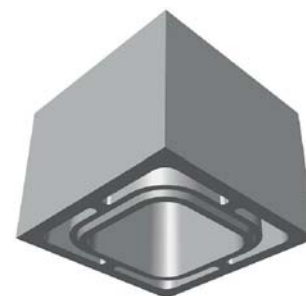
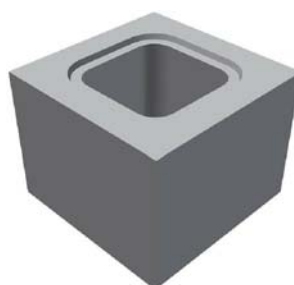
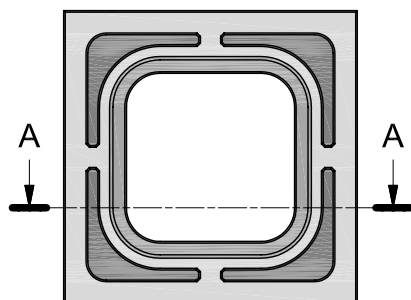

A-A

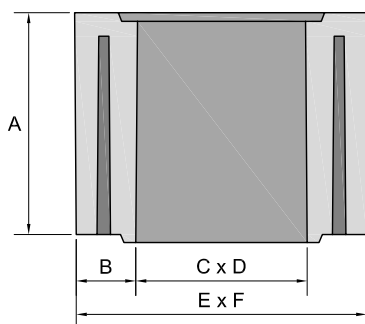

Code Article	Désignation	A (mm)	B (mm)	C (mm)	D (mm)	E (mm)	F (mm)	Poids (Kg)	NF
380015	200 x 200	330	80	200	200	360	360	44,5	NF
380020	200 x 400	250	55	200	400	310	510	33	NF
380027	250 x 250	330	90	250	250	430	430	62,5	NF

Nota : Les informations relatives au marquage  et autres caractéristiques sont disponibles sur simple demande
Nous ne fabriquons pas de pièces spéciales.

S.A. R.THEBAULT

Siège social et usine : ZI de Saint-Eloi - Plouédern - 29800 LANDERNEAU

Tél. 02 98 21 63 63 - Fax : 02 98 21 34 11

Usines à : Mauron (56430) et Verneuil S/Avre (27130)